

Quick Start Guide



AXIUM DX8000

GETTING STARTED

Set up your DX8000 in a convenient location close to a power source. Connect the power cable to the power supply and the USB connector socket of the terminal.

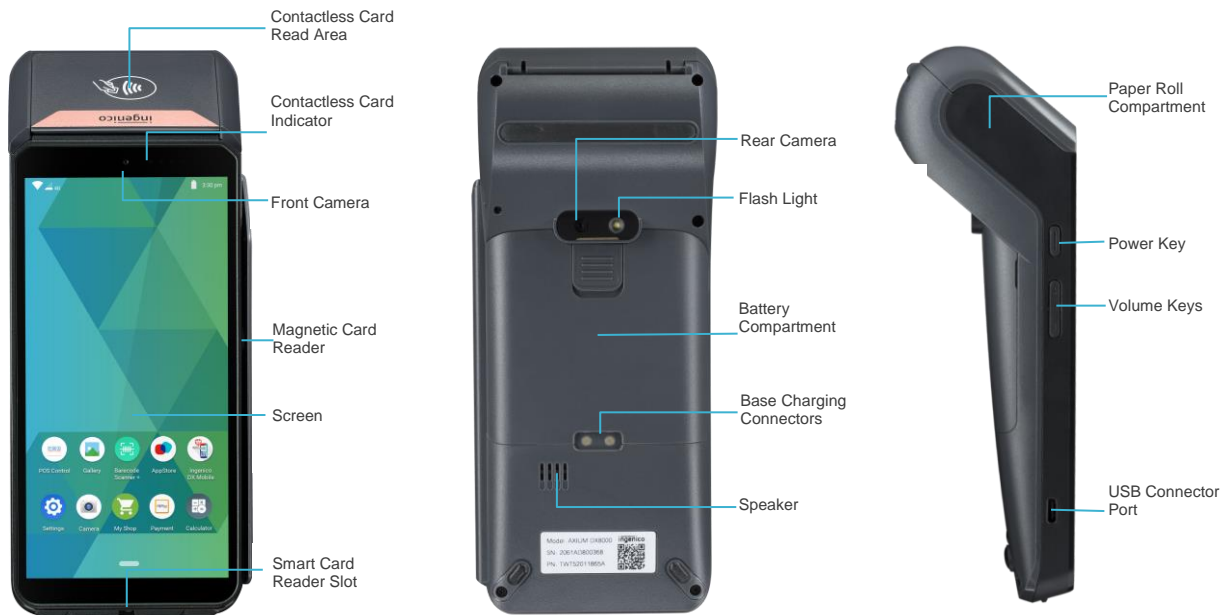

CHANGING THE PAPER ROLL

Hold the terminal in one hand. Open the paper roll compartment by lifting the catch located at the top of the DX8000. Fully open the printer cover and remove the old paper roll.

Unstick the end of the new roll and insert the paper roll in the compartment as shown below:

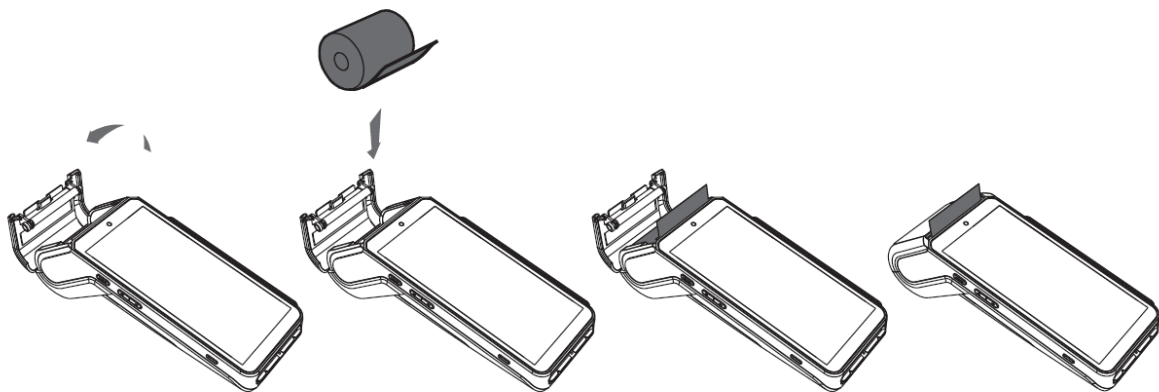

Pull the paper to the top of the terminal. Holding the free end of the paper, close the cover. Press simultaneously on both upper corners of the cover until it clips into position.

ONLY OPEN THE PRINTER COVER AS SHOWN - DO NOT FORCE THE PRINTER COVER

INSTALLING THE TERMINAL



Power the terminal on by pressing the power key for 3 to 4 seconds. From the initial power on screen swipe right or left, then tap the NER PAY icon.

1

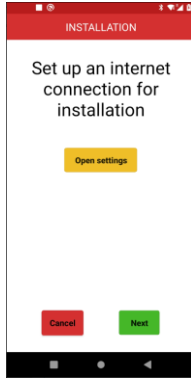

Select Open settings.

2

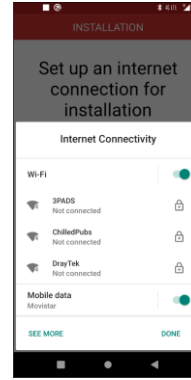

The terminal will scan for local available networks and provide a list to select from.

3

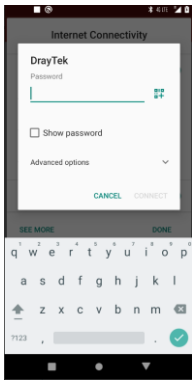

Tap the Wi-Fi network option that the terminal is to be connected to.

4

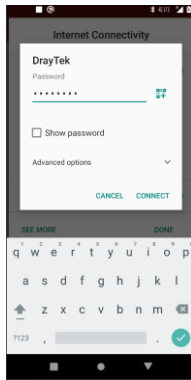

Enter the relevant password of the network, then select CONNECT

5

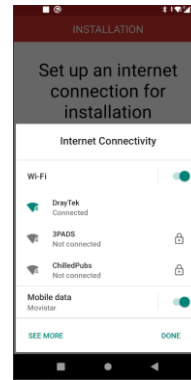

A successful connection is indicated with the icon turning green. Select DONE, the terminal will return to the initial installation screen

6

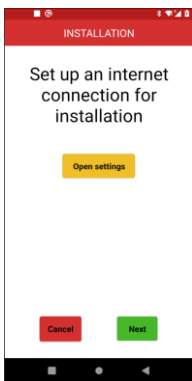

Select NEXT. The terminal will connect to the configuration system. Please wait will be displayed during this phase.

7

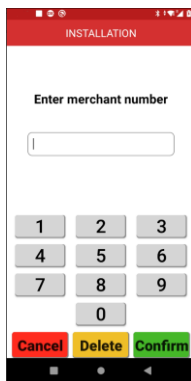

Enter the merchant number you have been provided with then select CONFIRM

8

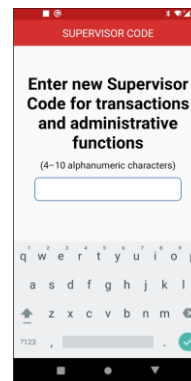

You will be prompted to enter a supervisor code. Enter a supervisor code of your choice.

9

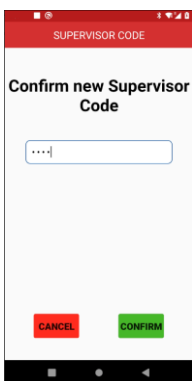

Select  then select CONFIRM

10

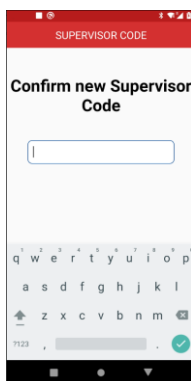

Confirm the supervisor code by re-entering it, then select CONFIRM.

11

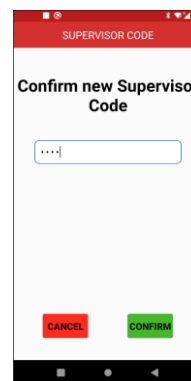

The application is now configured and will close. To start using the terminal for transactions tap the NER PAY icon to re-open the application.

12



THE CHIP CARD READER

Customer cards must be inserted as shown, with the chip upwards. Push the card fully into the slot below the screen and follow the instructions on screen.

If you see a "Please Insert Again" message, check the card orientation and try again.

DO NOT remove the card until instructed to do so by the terminal.

Chip & PIN Transactions – SALE

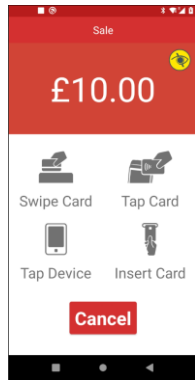
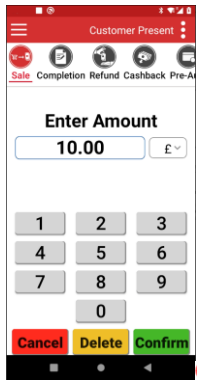

Select SALE from the menu options.

Enter the sale amount for the transaction and tap **CONFIRM**

For example, enter £12.34 as 1234

The customer's card should be inserted into the card reader.

The customer must enter their PIN code.

NEVER ASK THE CUSTOMER TO DIVULGE THEIR PIN CODE.

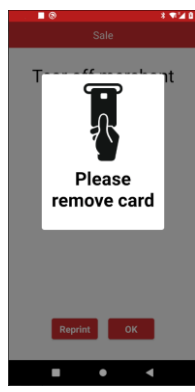
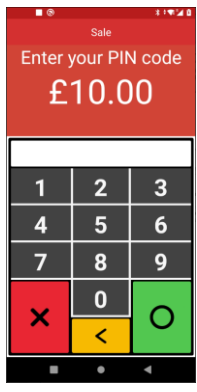

After the customer has entered their PIN and pressed **CONFIRM**, the terminal will connect to the acquirer for authorisation.

If the transaction is authorised the terminal will display 'Transaction Approved'

The terminal will print two receipts. The merchant copy will be printed first. After confirming a successful print by selecting OK, the terminal will prompt for the card to be removed. The customer receipt will be printed after the card's removal

Chip & PIN Transactions – REFUND

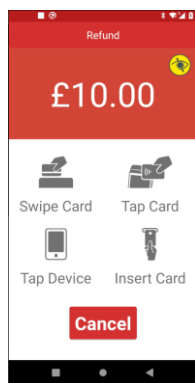
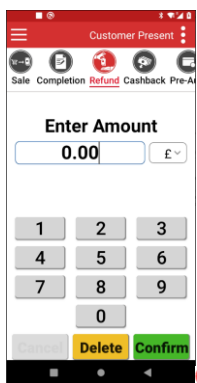

Select REFUND from the menu options.

Enter the refund amount for the transaction and tap **CONFIRM**

The customer's card should be inserted into the card reader.

Once the customer's card is presented you will be prompted for the Supervisor Code.

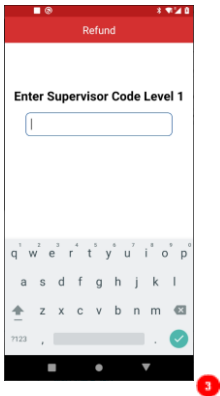

The terminal will now connect to the acquirer for authorisation, if the refund is authorised then “REFUND ACCEPTED” will be shown.

The terminal will print the merchant receipt which the customer must sign. Remove the card.

Check the signature on the merchant copy with that on the card. If the signature is valid then choose “YES”, otherwise choose “NO”.

The terminal will then print the customer copy.

Contactless – SALE

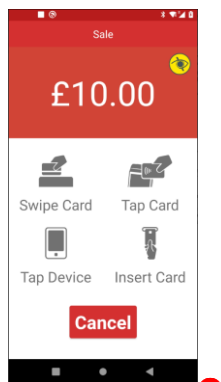
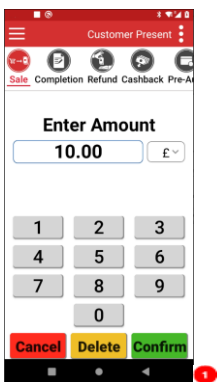

Select SALE from the menu options.

Enter the sale amount for the transaction and tap **CONFIRM**.

The cardholder should present their card/payment device to the top of the terminal where the contactless symbol is displayed.

The terminal will contact the acquirer for authorisation.

A merchant receipt will then be printed. The terminal will then present the option for a customer receipt to be printed, select No or Yes as appropriate.

Transaction Receipt – (Merchant Copy – CHIP & PIN card)

MERCHANT NAME	
Merchant Address 1	
Merchant Address 2	
<i>Merchant ID</i>	MID: 12345678
	TID: 63600000 <i>Terminal ID</i>
	AID A0000000031010
<i>Card AID & Label</i>	VISA PREFERRED
	VISA <i>Card Issuer</i>
	4444 3333 2222 1111 <i>Card Number</i>
	START 07/95 EXP 12/22
<i>Entry Method</i> <small>ICC for Inserted Cards SWIPED for Swiped Cards KEYED for Keyed Cards CONTACTLESS for Contactless Cards</small>	ICC PAN SEQ 1
	SALE <i>Transaction Type</i>
MERCHANT COPY	
AMOUNT £10.00	
	VERIFIED BY PIN <i>Successful PIN Entry</i>
PLEASE DEBIT MY ACCOUNT WITH THE ABOVE AMOUNT	
<i>Date & Time</i>	10:10:10 01/10/20
	AUTH CODE: 123ABC <i>Auth Code</i>
<i>Transaction Number</i>	RECEIPT: 0001

Mail Order – SALE

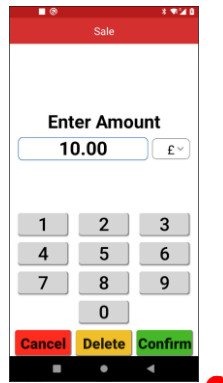
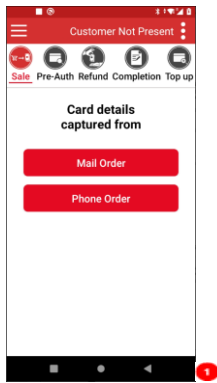

Change the selected service to Customer Not Present.

This is achieved by tapping the  icon in the top right of the display. Tapping the Select Service option popup and selecting the Customer Not Present option presented.

Select the appropriate card capture detail option for the transaction.

Key in the amount for the transaction and select .



Type in the customer's card number expiry date and security code then select .

If there are numbers in the customer post code select .

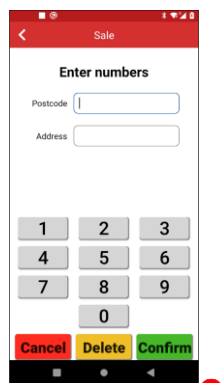

Enter the numbers from the cardholder's postcode (e.g. NW1 6XG is 16), and the numbers from the cardholder's address (e.g. Flat 221b is 221) select .

The terminal will connect to gain authorisation. The result of the CSC/AVS check is then shown and will prompt you to choose "Decline" or "Accept".

End of Day Reports

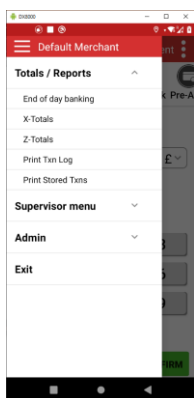

To access the reports menu, press the  option at the top left of the screen, then tap "TOTALS/REPORTS". Enter the Supervisor password and tap .

END of day banking: It is advised that this be done at the end of each day that you trade.

X-Totals: can be printed at any time throughout the day and give a sub-total of all transactions performed. X totals do not reset the totals within the terminal.

Z-Totals: show the total transactions taken since the last Z balance was completed. Once completed the totals within the terminal are reset to zero.

Copyright © 2022 Ingenico (UK) Ltd.

This Quick Start Guide relates to AXIUM DX8000 terminal – NER PAYMENT software.

Whilst every effort has been made to ensure that the content of this document is accurate, Ingenico will not accept responsibility for any loss, damage or injury that may be incurred as a result of any errors or inaccuracies. The product is varied to suit requirements and as such some features may vary or be disabled. This document should be accepted as a guide only to the use of the product.

In the effort for continued improvements in design and quality, products features and information regarding setting up, installation and use of all Ingenico products is subject to change without prior notice.